

# BARACUDA<sup>®</sup>

For Everyday Aussie pools

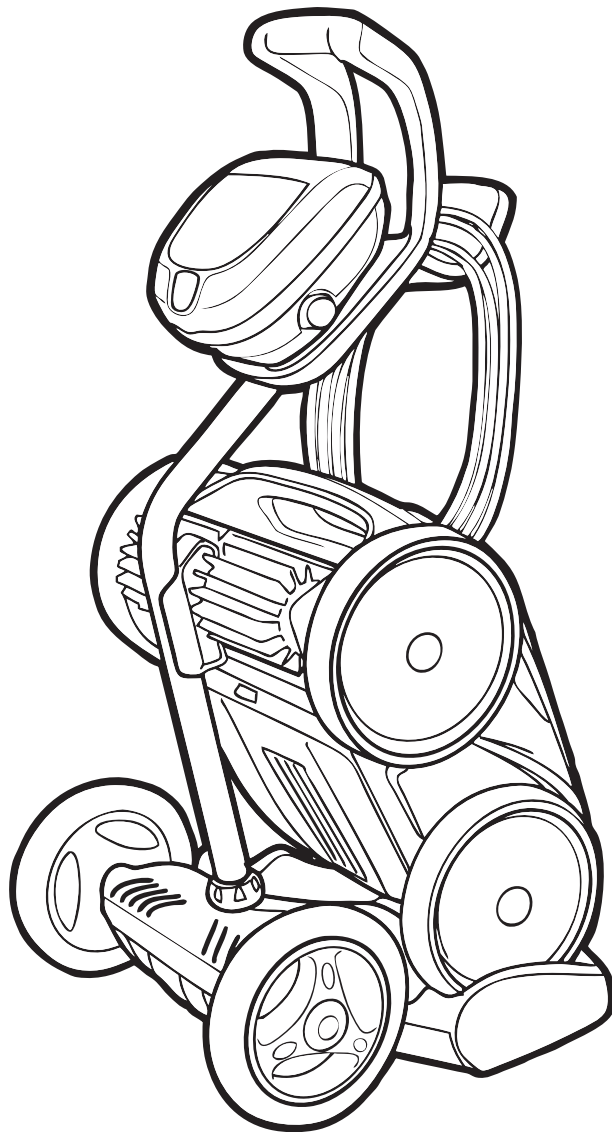

TYPE EM14 --

TYPE EM15 --

adventura<sup>™</sup>  
Robotic Pool Cleaner

## Introduction

Congratulations on the purchase of your new BARACUDA Adventura robotic pool cleaner. Your Adventura is designed and manufactured for easy installation, and years of carefree operation. Before installing the cleaner, please take a few moments to become familiar with its components and to review the items listed under Important Information.

## Table of Contents

Section 1. Important Safety Instructions.....3	Section 5. Maintenance.....11
Section 2. Getting Started.....4	5.1 Cord Tangling.....11
2.1 General Specifications.....4	5.2 Replacing the Brushes.....11
Section 3. Assembly.....4	5.3 Replacing the Track.....12
3.1 Unpacking.....4	Section 6. Troubleshooting.....13
3.2 Assemble the Transport Caddy.....4	6.1 Using the Information LED.....13
3.3 Connecting the Control Unit to the Caddy.....5	6.2 General Troubleshooting.....14
Section 4. Operation.....7	Section 7. Conformity.....15
4.1 Submerging the Cleaner.....7	
4.2 Using the Control Unit.....8	
4.3 Start / Stop Cleaning.....8	
4.4 Lift System / Removal From Pool.....8	
4.5 Rinsing the Cleaner.....9	
4.6 Cleaning the Filter Canister.....9	
4.7 Storing the Cleaner.....10	

### Suitable Pools

The BARACUDA Adventura is suitable for most domestic in-ground pools up to 12m x 6m.

Pool surfaces include: Concrete, pebblecrete, quartzon, fibreglass, tile and vinyl. Not suitable for above ground pools. Suitable for all types of debris.

YOUR CLEANER HAS BEEN DESIGNED AND MANUFACTURED TO BE EASILY INSTALLED AND TO PROVIDE LOW MAINTENANCE OPERATION. A WARRANTY CARD IS SUPPLIED IN THE BOX. PLEASE GO TO BARACUDA.COM. AUTO REGISTER FOR WARRANTY.

Taking these steps will help ensure prompt warranty service, should it be required. If service is required, please contact your original dealer. If the original dealer does not perform warranty service, please visit [www.baracuda.com.au](http://www.baracuda.com.au) to locate an independent service company near you. If you are unable to locate a service company, please call our Baracuda Customer Service at 1300 784 423.

## Section 1. Important Safety Instructions

### **⚠ WARNING**

Failure to comply with the following warnings can result in permanent injury, electrocution or death.

#### **PREVENT ELECTRICAL SHOCK**

To reduce risk of electrical shock:

- The cleaner is to be installed in accordance with the relevant requirements of the Australian wiring rules AS/NZS 3000. Also refer to the installation instructions relating to the swimming pool equipment for which the cleaner will be an integral part. The cleaner is to be supplied through a Residual Current Device (RCD) with a rated residual operating current of 30mA.
- Do not enter pool while the robotic cleaner is in water.
- Do not bury cord. Locate cord so as to prevent it from being damaged by lawn mowers, hedge trimmers and other equipment.
- To reduce the risk of electrical shock, do not use the robotic cleaner or control box if the cord is worn or damaged. Contact Baracuda Customer care Service 1300 784 423 immediately for proper servicing and replacement of the damaged cord.
- Double insulation—For continued protection against possible electric shock, use only identical replacement parts when servicing. Do not attempt repair of the robotic cleaner, control box, power cord, or floating cable.
- Use only the power supply provided with the product.
- NEVER OPEN Control box.
- Do not use an extension cord to connect the unit to electric supply; provide a properly located RCD PROTECTED Power outlet. The control box should be placed near the RCD PROTECTED GFCI Power outlet point.

#### **PREVENT CHILD INJURY AND DROWNING**

- To reduce the risk of injury, do not permit children or persons with reduced physical, sensory or mental capabilities, or lack of experience and knowledge to operate this product.
- Do not let anyone, especially small children, sit, step, lean, or climb on any equipment installed as part of your pool's operational system.

### **⚠ CAUTION**

Failure to comply with the following warnings could cause damage to pool equipment or personal injury.

- The robotic cleaner must be installed and operated as specified.
- This product is intended for use with permanently-installed pools. Do not use with storable pools. A permanently-installed pool is constructed in or on the ground or in a building such that it cannot be readily disassembled for storage. A storable pool is constructed so that it is capable of being readily disassembled for storage and reassembled to its original integrity.
- Clean the filter canister after each use.
- Do not use the product in your pool if the water temperature is above 35° C (95° F) or below 13° C (55° F).

### **⚠ CAUTION**

#### **USE OF THE BARACUDA ROBOTIC CLEANER IN A VINYL LINER POOL**

Certain vinyl liner patterns are particularly susceptible to rapid surface wear or pattern removal caused by objects coming into contact with the vinyl surface, including pool brushes, pool toys, floats, fountains, chlorine dispensers, and automatic pool cleaners. Some vinyl liner patterns can be seriously scratched or abraded simply by rubbing the surface with a pool brush. Ink from the pattern can also rub off during the installation process or when it comes into contact with objects in the pool. Fluidra Group Australia Pty Ltd is not responsible for, and the Limited Warranty does not cover, pattern removal, abrasion or markings on vinyl liners.

## SAVE THESE INSTRUCTIONS

## Section 2. Getting Started

### 2.1 General Specifications

The general specifications for the cleaner are as follows:

Control box supply voltage	 220-240 VAC, 50 Hz; short circuit-proof safety isolating type
Supply voltage	30 V DC
Installed load	150 W max
Cable length	18m
Cleaner size (WxDxH)	43 x 48 x 27 cm
Weight of Cleaner	9.5 kg
Package Weight	19 kg
Filtration	All-purpose filter canister
Cycle lengths	Variable programming

The cleaner is a double-insulated product. A double insulated electrical appliance is one which has been designed in such a way that it does not require a safety connection to ground. The basic requirement for double-insulation is that no single failure can result in dangerous voltage becoming exposed so that it might cause an electric shock and that this is achieved without relying on an earthed (grounded) metal casing. This is achieved by having two (2) layers of insulating material surrounding live parts or by using reinforced insulation. Therefore, devices having double-insulated construction, such as this cleaner, do not utilize a grounded (three-prong) cord/plug.

## Section 3. Assembly

### 3.1 Unpacking

The packaging should contain the following items:

- Adventura cleaner
- Control unit
- Transport and storage caddy

Transport and storage caddy components:

- handle frame
- support blocks (x 2)
- wheels (x 2)
- wheel locking clips (x 2)
- wheel axle / hubcap (x 2)
- base unit
- cleaner hook
- caddy handle

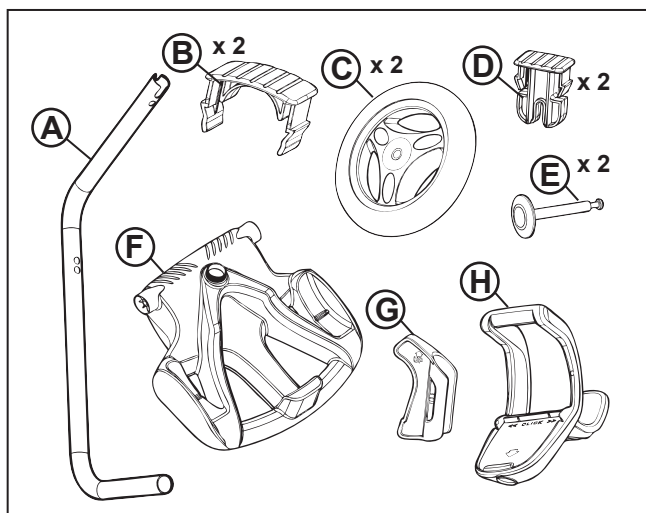

Figure 1. Align Control Unit with Caddy Hook

When unpacking the cleaner and its components:

- Check to make sure each component is in the box.
- Check cleaner and components for damage during transport.
- If there are any missing parts or damage, contact Technical Support at 1300 186 875

### 3.2 Assemble the Transport Caddy

1. Unscrew the handnut from the base.

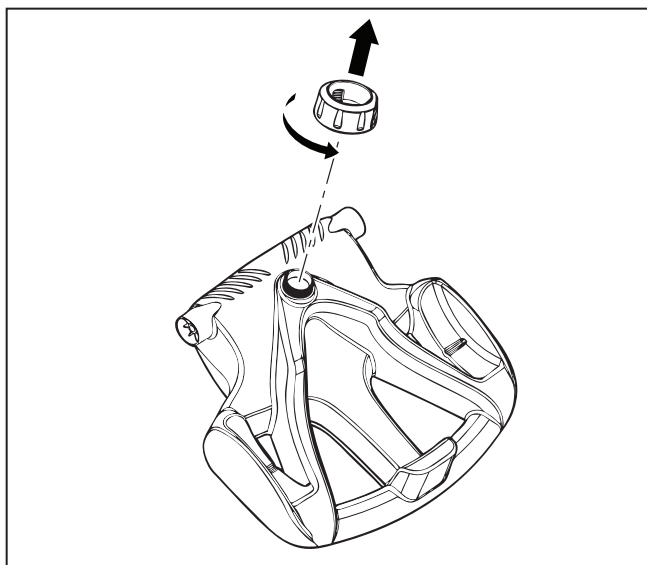

Figure 2. Remove Handnut from Base Unit

2. Insert the metal handle frame tubing into the base with notch end at the top, then rotate so the bends are away from you.
3. Push base down so the metal handle frame is seated in the recess on the underside of the base.

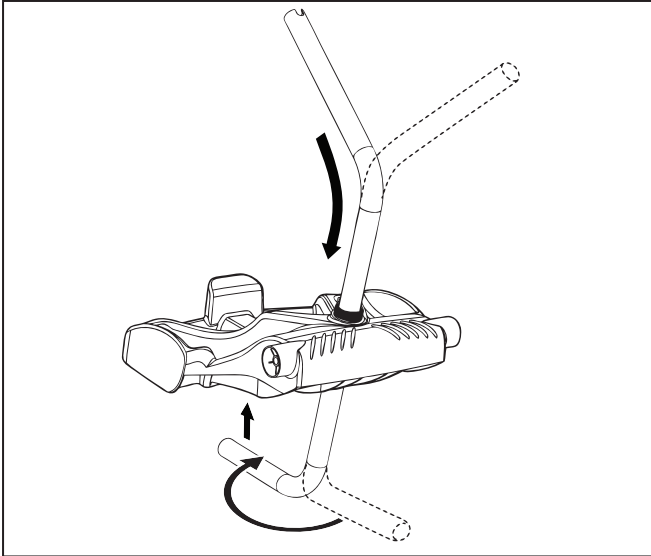

Figure 3. Connect Metal Frame to Base Unit

4. Slide the handnut over the tube and twist to tighten onto base unit.

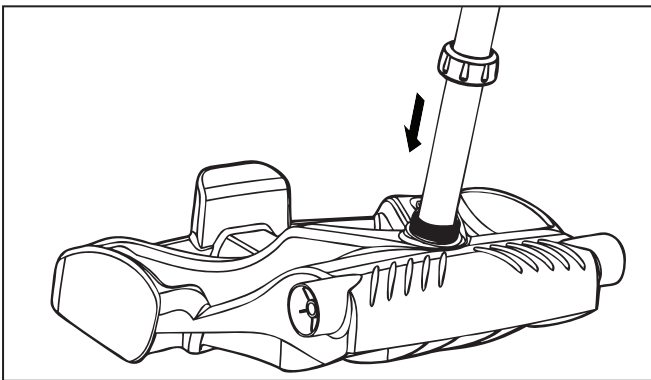

Figure 4. Twist Handnut to Secure Frame

5. Snap two (2) support blocks into place.
6. Slide axle and hubcap piece through center of wheel and attach to base unit. Snap locking clip into place to secure wheel. Repeat to attach both wheels.

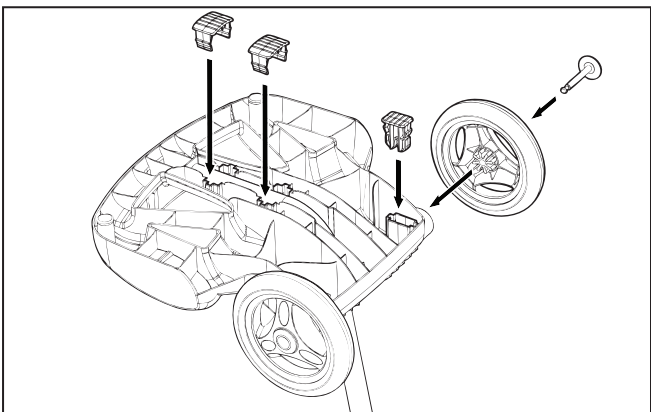

Figure 5. Snap in Support Blocks and Attach Wheels

7. Slide the control unit base / caddy handle attachment down over the metal tubing until it snaps into place.

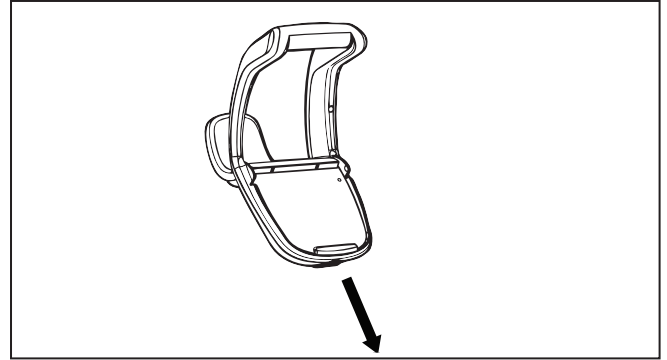

Figure 6. Attach Caddy Handle

8. Align cleaner hook pins with the top holes in the handle tube and snap into place.

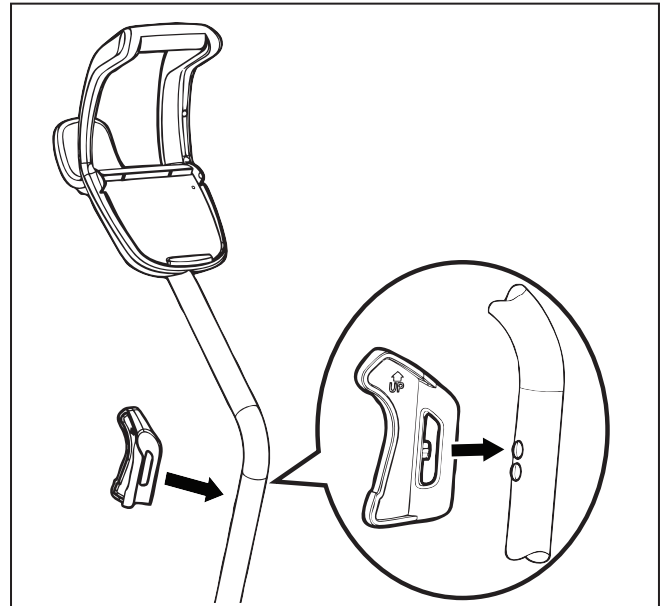

Figure 7. Snap Cleaner Hook into Place

### 3.3 Connecting the Control Unit to the Caddy

1. Align the bottom of the control unit with the notch at bottom of the control unit hook on the caddy (Figure 8).

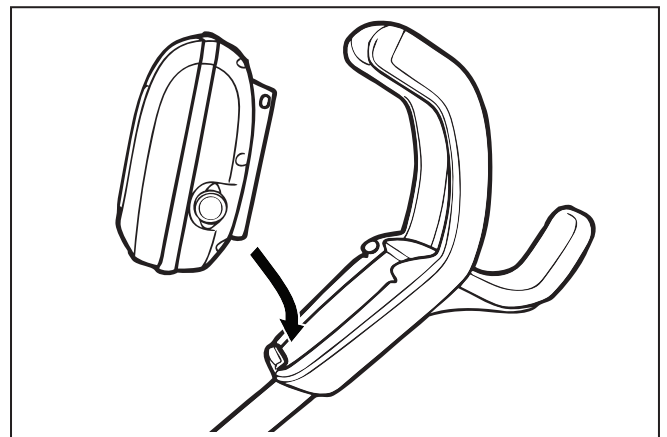

Figure 8. Align Control Unit with Caddy Hook

2. Press control unit onto the caddy hook until it snaps and locks into position (Figure 9).

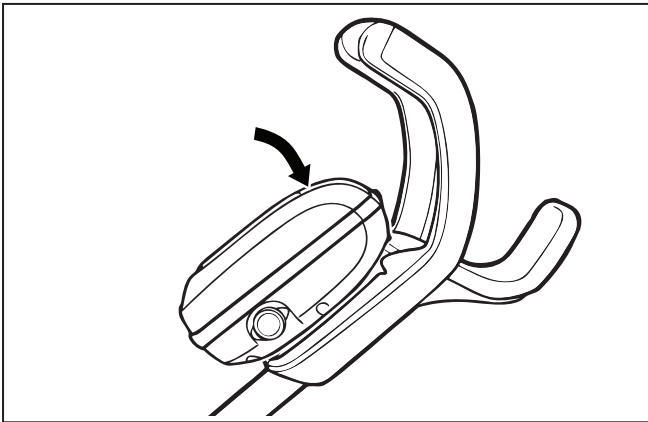

Figure 9. Attach the Control Unit onto Caddy

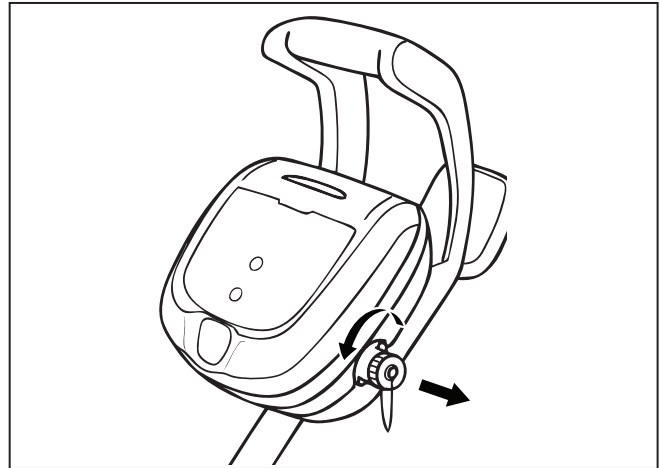

Figure 10. Remove Protective Cap

### 3.4 Connecting to Power Source

#### **⚠ WARNING**

Failure to comply with the following warnings can result in permanent injury, electrocution or drowning.

#### PREVENT ELECTRICAL SHOCK

- Keep the Control box at least 3.5 m from the edge of the pool.
- The cleaner is to be installed in accordance with the relevant requirements of the Australian wiring rules AS/NZS 3000. Also refer to the installation instructions relating to the swimming pool equipment for which the cleaner will be an integral part. The cleaner is to be supplied through a Residual Current Device (RCD) with a rated residual operating current of 30mA.
- Do not use an extension cord to connect the Control box.
- Do not allow anyone to swim while the cleaner is in the pool.
- The control box is water-resistant, not waterproof. In order to prevent electrocution, never submerge the Control box or leave exposed to inclement weather.

1. Unscrew the protective cap for the power cable from the side of the control unit by turning counter-clockwise (Figure 10).

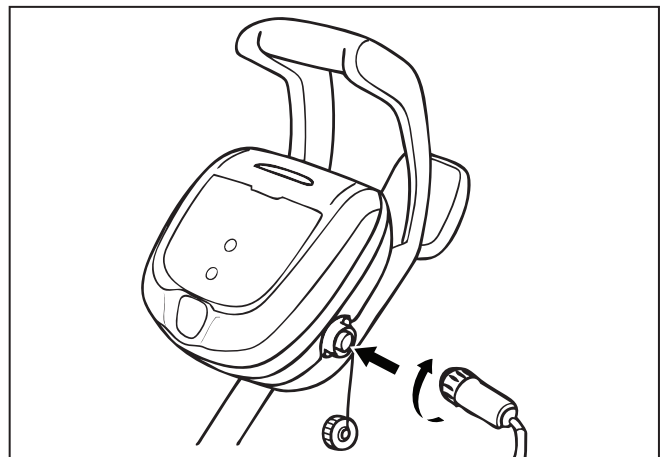
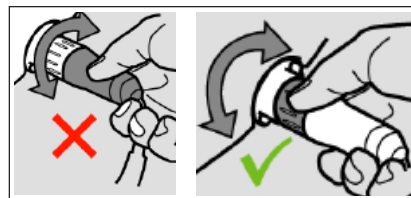

Figure 11. Connect Power Cable

2. Grip the notched end of the floating power cable, insert it into the control unit, and turn clockwise to tighten. (Figure 11).

**NOTE:** To avoid damaging the power cable, do not try to twist the entire cable housing (see below).



**NOTE:** To avoid exposing the power cable connector pins to water, be sure the connector is screwed in all the way and there is no gap. (see below).

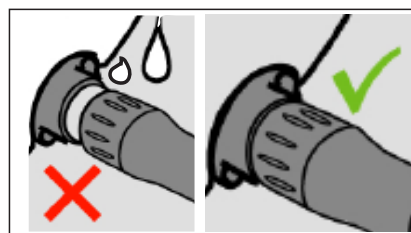

## Section 4. Operation

### ⚠ CAUTION

To prevent damage to the cleaner, be sure to adhere to the following guidelines:

- Remove the cleaner from the pool after the cleaning cycle is completed and store out of direct sunlight or inclement weather.
- Take additional care when lifting the cleaner out of the pool. It becomes heavier when filled with water.
- Always remove the cleaner from pool before adding chemicals.
- Do not handle cleaner while it is in operation.

### IMPORTANT

- Always make sure the cleaner head is fully submerged before you begin operation.
- Clean the canister after each cleaning cycle.
- Do not leave your cleaner in the pool on a permanent basis.
- At the end of each cycle, remove the cleaner from the pool. Start at the cleaner head and untangle any coils in the cable before storing the cleaner.

The Adventura robotic cleaner includes a safety feature that automatically stops the cleaner if it is powered on but not submerged in water. For pools equipped with a beach area, this safety feature is programmed to drive the cleaner in reverse and back into the pool when the impeller is out of the water.

#### 4.1 Submerging the Cleaner

1. Submerge cleaner vertically (1) and hold it under the surface, moving gently from side to side (2) until the bubbles stop to remove air trapped inside (Figure 12).
2. When the bubbles stop, allow the cleaner to sink to the bottom of the pool.
3. Verify the cleaner is sitting on the bottom of the pool. Remove additional air if the cleaner is still floating.

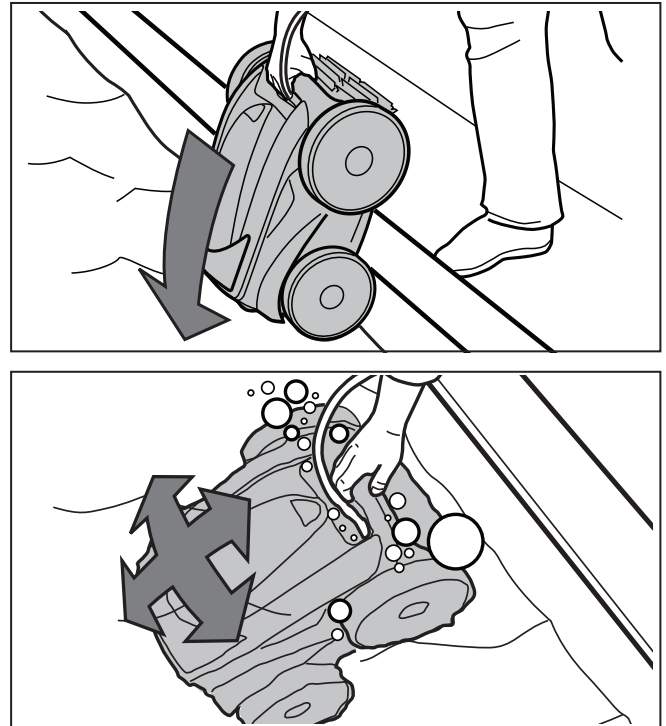

Figure 12. Submerge and Remove Trapped Air

4. Place only enough floating cable in the water to reach the farthest end of your pool from the central point. Spread out the floating cable ensuring there are no kinks or coils in the cable (Figure 13).

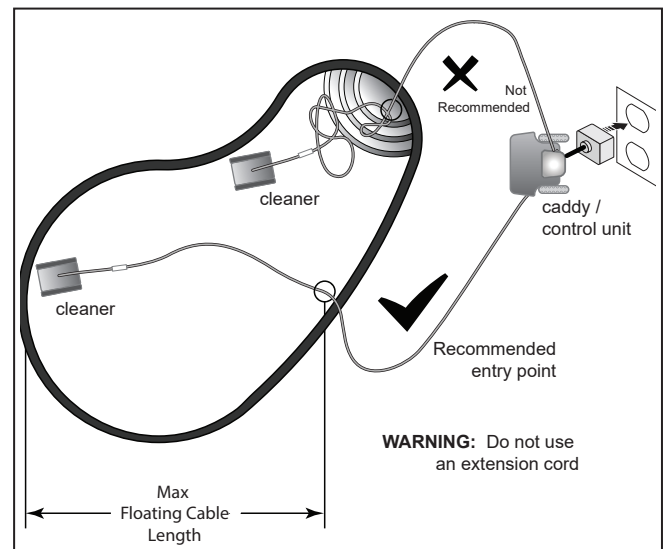
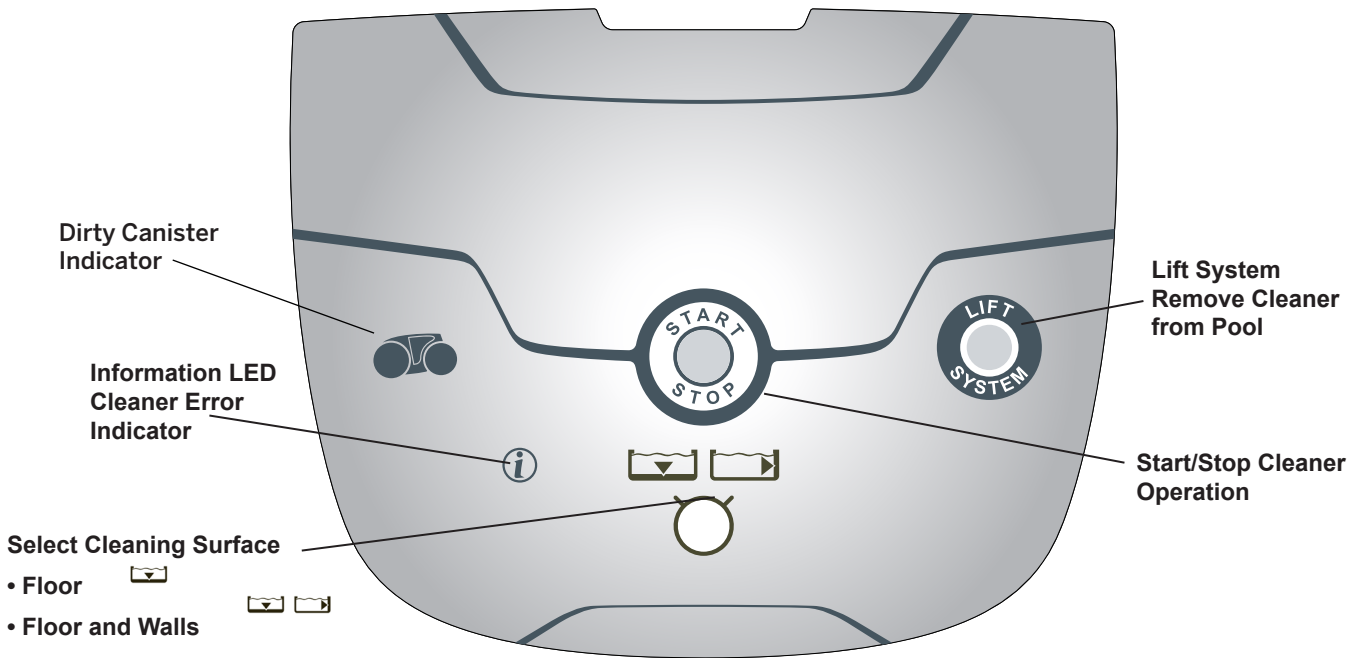

Figure 13. Pool Entry Point for Optimal Patterning



5. Spread the floating cable over the pool, making sure there are no kinks or coils in the cable. Allow enough floating cable for the cleaner to reach the farthest point of the pool.

## 4.2 Using the Control Unit



## 4.3 Start / Stop Cleaning

The factory default cleaning surface setting is Floor and Walls .

- Use  to change cleaning surface setting.
- Toggle between: Floor Only  Floor and Walls 
- With cleaner submerged in the water,

press  to begin operation.

## 4.4 Lift System / Removal From Pool

The Lift System is designed to assist in retrieving the robot from the pool. The Lift System can be activated at any time during or after a cleaning cycle.

1. Press  on the Control Unit to begin the automated procedure to bring the cleaner to the wall.

**NOTE:** To stop the procedure at any time, press and release the button again.

2. Next, press and HOLD to rotate the cleaner.

3. Once the cleaner is facing the wall of your choice for retrieval, release the button.
4. Cleaner will drive forward and up the wall it is facing. It will wait at the waterline to be retrieved.
5. When the cleaner is within arm's reach, use the handle to lift it from the water (Figure 14).

**NOTE:** Never lift the cleaner out of the pool by the floating cable.

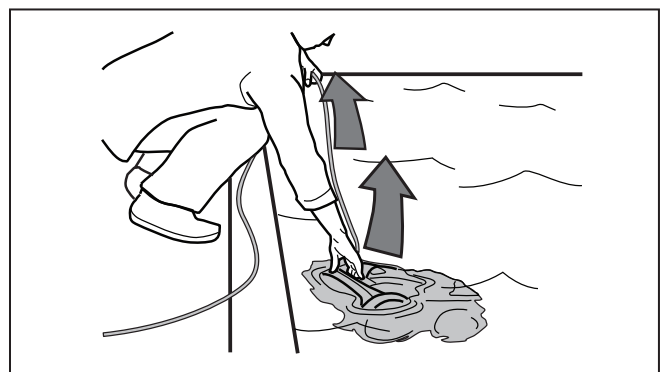

Figure 14. Lift Cleaner From Pool with Handle

6. Hold the cleaner vertically over the pool surface to drain water before removing (Figure 15).



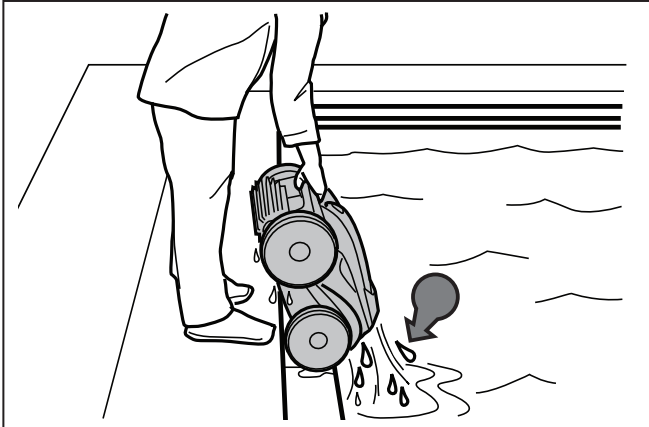

Figure 15. Lift Cleaner From Pool with Handle

### CAUTION

Use care and correct lifting technique when lifting heavy objects. Incorrect removal of the cleaner from the pool can cause muscle strain or back injury.

#### 4.5 Rinsing the Cleaner

Rinse the cleaner after every cleaning cycle. Use slightly soapy clean water, then rinse generously with clean water. Do not use solvents such as acetone or its equivalent. Do not let your cleaner dry in direct sunlight near the pool.

#### 4.6 Cleaning the Filter Canister

### WARNING

To avoid electric shock and other hazards which could result in permanent injury or death, disconnect (unplug) the control box from the power source before performing any cleaning and maintenance.

1. Make sure the control box cable is disconnected from the electrical outlet or the floating cable has been disconnected from the control box.
2. Remove the cleaner from the water and let the remaining water drain by maintaining the cleaner in the vertical position.
3. Set the unit on its wheels.
4. Push the cover lock and lift the cover until it is secured in the vertical position (Figure 16).

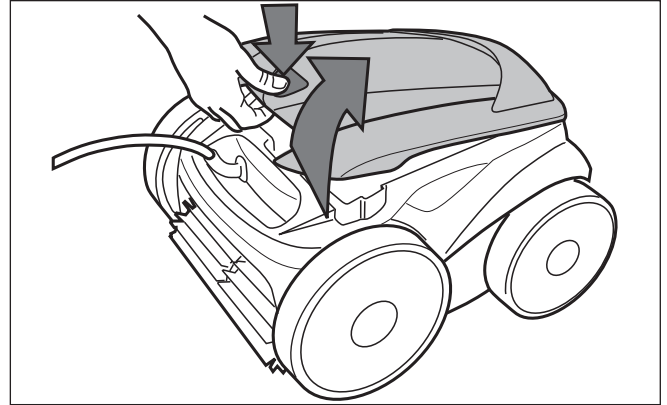

Figure 16 Lift Cleaner Cover

5. Remove the filter canister assembly from the body (Figure 17).

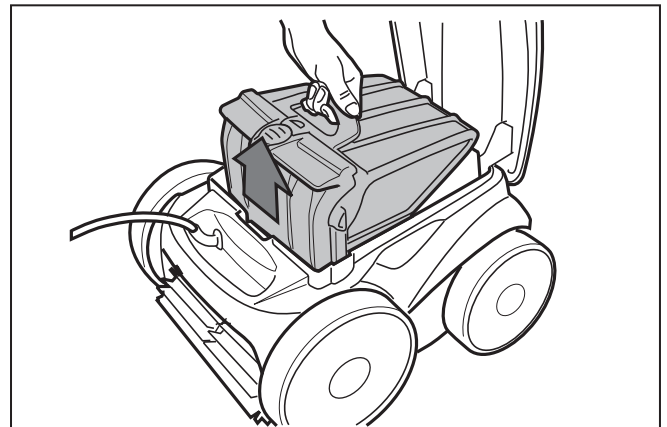

Figure 17. Remove the Filter Canister

6. Push the quick release button on the canister assembly and pull open the filter assembly (Figure 18).

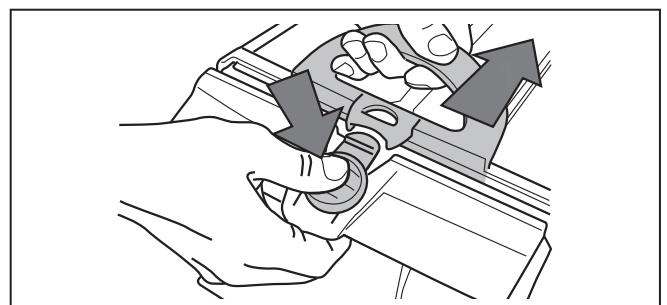

Figure 18. Release Filter Canister Handle

7. Separate the filter canister from the filter support (See Figure 19).

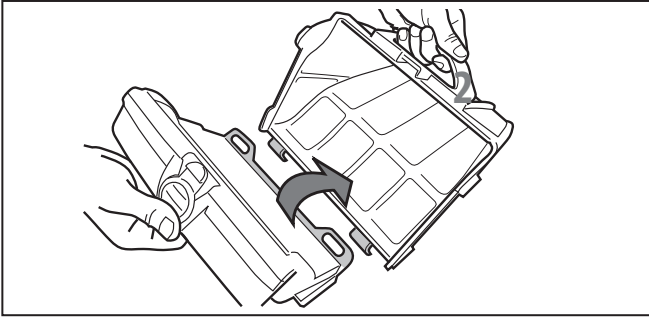

Figure 19. Release Filter Canister Handle

8. Empty all debris from the filter canister, then rinse the canister, the filter support, and the cleaner under water or using a hose (Figure 20).

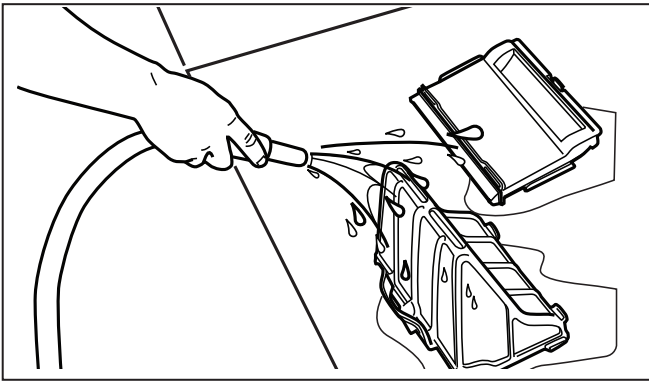

Figure 20. Rinse the Filter Canister

9. Let the lid and filter canister dry.
10. Replace lid on the canister and then replace canister back into the cleaner body.
11. Plug the floating cable back into the Control box and store the cleaner out of direct sunlight for next use.

#### 4.7 Storing the Cleaner

The cleaner must be cleaned regularly using slightly soapy clean water. Do not use solvents such as acetone or its equivalent. Rinse the cleaner generously using clean water. Do not let your cleaner dry in direct sunlight near the pool. The cleaner must be stored on its caddy so that it dries quickly.

1. Starting at the cleaner head. Remove all coils and tangles from the cable (see Figure 21).

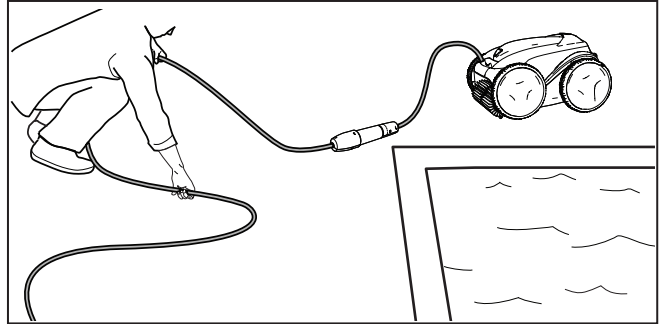

Figure 21. Untangle the Floating cable

2. Place the cleaner in vertical position on the caddy base with the rear tracks on the caddy side wedges (see Figure 22).

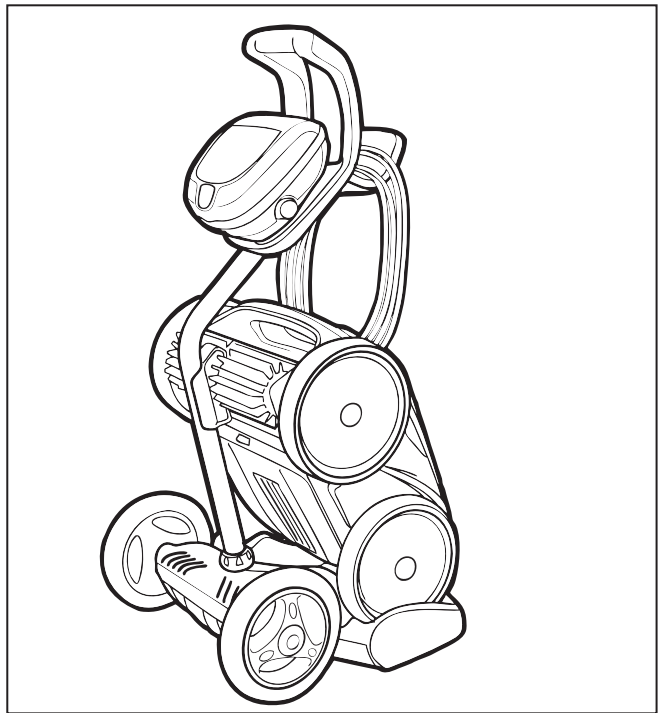

Figure 22. Cleaner Stored Correctly on Caddy

3. Loosely coil the power cable starting at the cleaner and moving toward the connection point at control unit. Store the cable by wrapping it around the hook located on the front of the caddy.

### **⚠ WARNING**

To avoid electric shock and other hazards which could result in permanent injury or death, disconnect (unplug) the cleaner from the power source before performing any cleaning and maintenance.

## Section 5. Maintenance

### 5.1 Cord Tangling

#### IMPORTANT

The floating cable may become tangled if correct procedure is not followed after each cleaning cycle.

After every cleaning cycle:

1. Unplug the floating cable from the Control box.
2. Remove the cleaner from the pool and untangle all kinks and coils in the floating cable starting at the cleaner head (Figure 23).

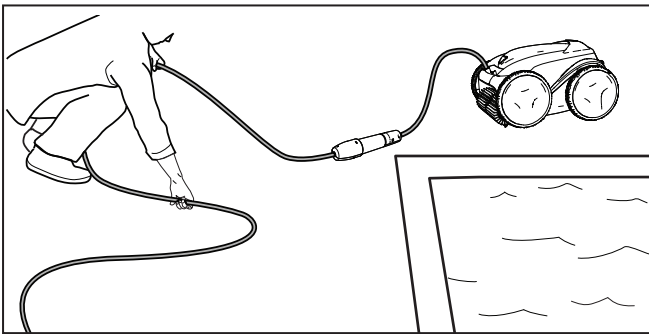

Figure 23. Untangle the Floating Cable

3. Plug the floating cable back into Control box and store cleaner out of direct sunlight for next use.

### 5.2 Replacing the Brushes

The cleaner is fitted with PVC brushes. There are "wear" indicators (Figure 24) on the brushes. To maintain cleaner performance at its best you need to replace the brushes as soon as one of the wear indicators has been reached (even if the blade wear is not even). Baracuda recommends that you replace the brushes when the rubber is worn down to the top of the wear indicator (or every two years, whichever comes first).

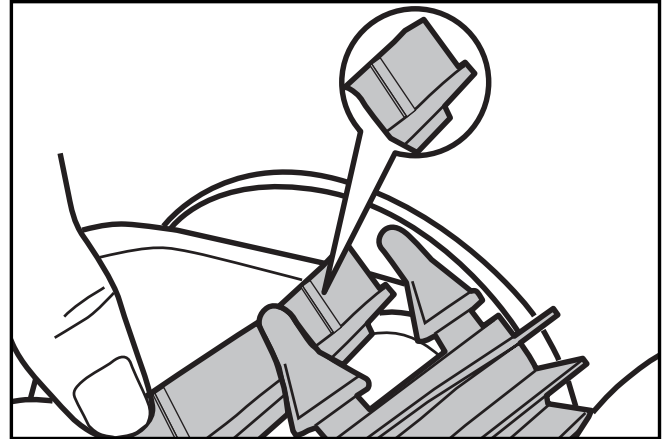

Figure 24. Wear Indicators

1. Stand the cleaner on its end in a vertical position (Figure 25).

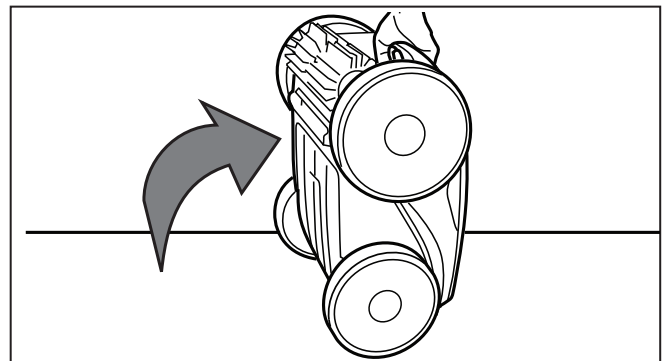

Figure 25. Stand Cleaner Upright

2. Separate the edges of the brush, undo the tabs, and remove the worn brush.
3. Position the new brush mat underneath the roller with the bristles facing downwards. Refer to Figure 26.

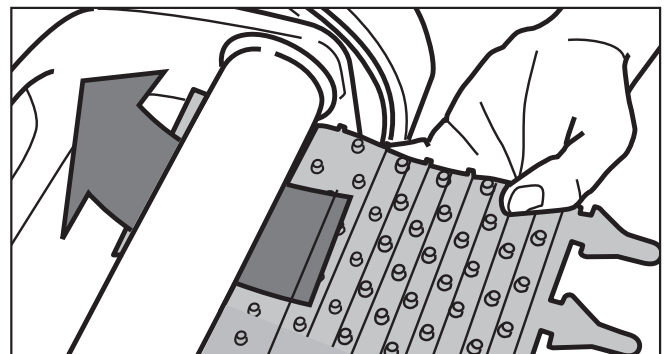

Figure 26. Position the New Brush on Roller

4. Thread each tab into the slot provided and gently feed it through until the heel comes out at the other side of the slot. Refer to Figure 27.

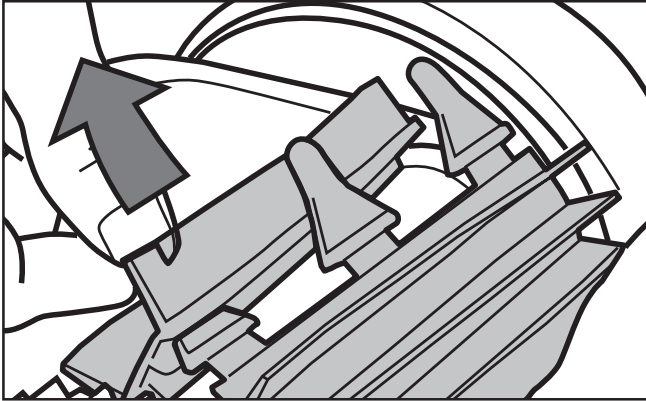

Figure 27. Pull Tabs Through Each Slot

5. Use scissors to cut the tabs at the guides, as shown in Figure 28.

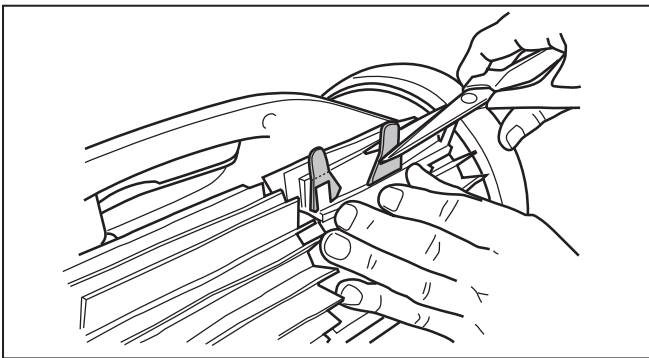

Figure 28. Stand Cleaner on its Side

6. Repeat this procedure to replace the second brush mat.

### 5.3 Replacing the Track

1. Starting at one of the wheels, pull on the inside of the track to separate the tire lip from the wheel. See Figure 29. Remove the old tyre from the cleaner.

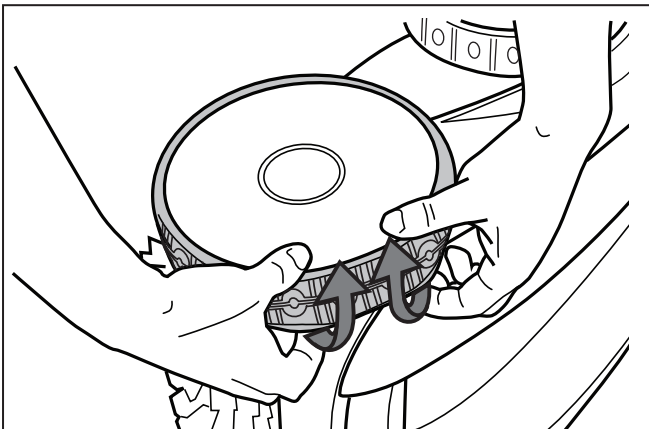

Figure 29. Pull the Track Over Wheels to Remove

3. Remove the old tyre. See Figure 30.

4. To replace the tyre, position the tyre on the wheel making sure to orient the tyre so that the word **INSIDE** is toward the body of the cleaner (Figure 30).

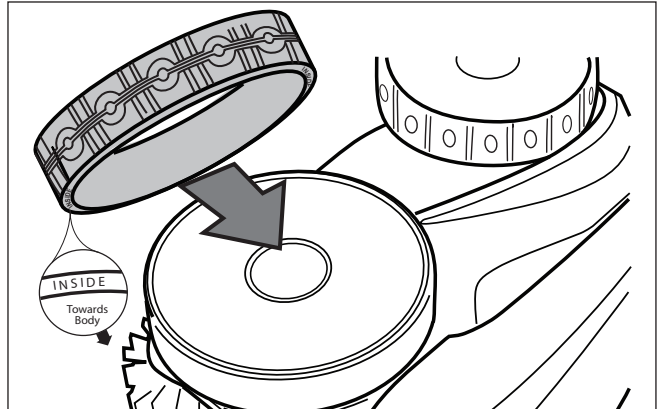

Figure 30. Tire Replacement Orientation

5. Push one side of the tire on to the wheel and fit the rib of the tire in the groove of the wheel (Figure 31).

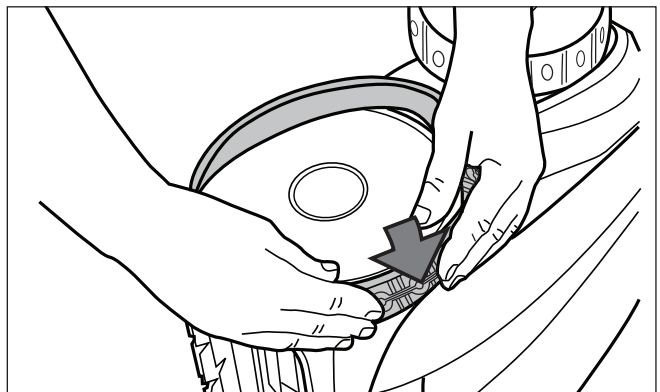

Figure 31. Start on One Side of the Tire

6. Work the tire onto the wheel and verify the rib of the tire is positioned properly within the groove of the wheel (Figure 32).

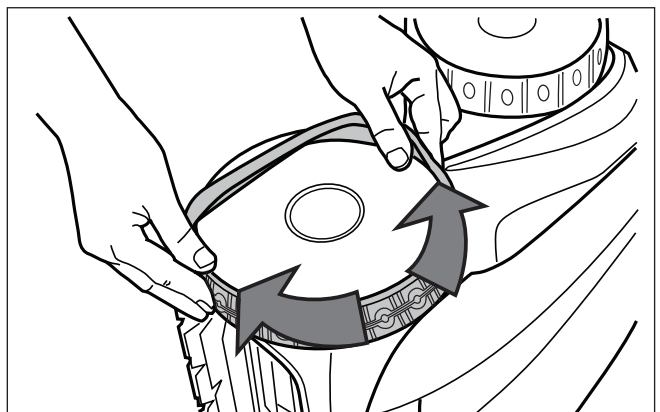

Figure 32. Work the Tire On Around the Wheel

7. Push and position the rib of the inner side of the tire in the groove of the wheel (Figure 33). If needed, turn the wheel gently to help with installation.

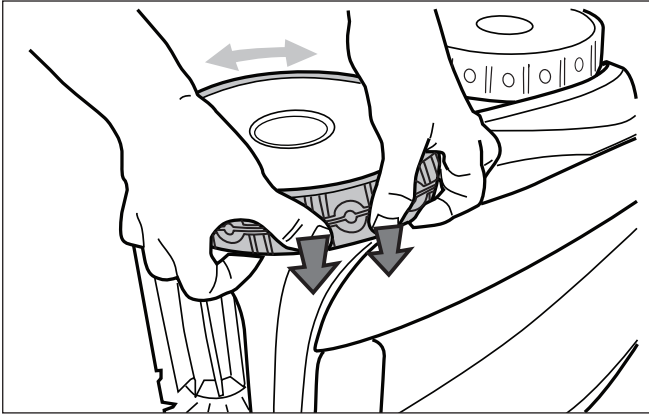

Figure 33. Push the Tire into Place on the Wheel

## Section 6. Troubleshooting

### 6.1 Using the Information LED

The information LED ⓘ on the Control box flashes in a specific sequence to indicate one of three possible cleaner malfunctions.

LED Flashing	Cause	Solution
1 Flash LED flashes once	Floating cable may not be plugged into the Control box correctly.	Unplug the floating cable from the Control box and reconnect. If the problem persists, contact Baracuda Customer Service at 1300 784 423
2 Flashes LED flashes twice	Cleaner wheels may be jammed or brushes may be blocked with debris.	Turn cleaner wheels to ensure they are not jammed. Check brushes for debris. Start a new cleaning cycle. If the problem persists, contact Baracuda Customer Service at 1300 784 423.
3 Flashes LED flashes three	Pump axis or propeller may be jammed with debris.  Dirty filter.	Check the pump axis for debris. Check propeller for debris. Clean the filter. Start a new cleaning cycle. If the problem persists, contact Baracuda Customer Service at 1300 784 423.

## 6.2 General Troubleshooting

The following table lists some of the common symptoms, causes, and solutions for correcting cleaner operation problems.

Problem	Cause	Solution
The Information LED flashes just after Start.	Floating cable may not be plugged into the Control box correctly.	Remove cleaner from the pool. Unplug floating cable from the Control box and reconnect.
	Cleaner may not be fully submerged.	Remove cleaner from the pool and re-submerge, see Submerging the Cleaner.
	Cleaner may need to be reset and begin a new cycle.	Remove cleaner from the pool. Press power button OFF, then begin a new cycle.
	Propeller may be jammed and not turning correctly.	Remove cleaner from the pool. Contact Baracuda Customer Service at 1300 784 423
	Wheels may be jammed and not turning correctly.	Remove cleaner from the pool. Contact Baracuda Customer Service at 1300 784 423
The Information LED flashes during the cleaning cycle.	Cleaner may be sucking air (lights will appear after 60 seconds air intake)	Remove cleaner from the pool and re-submerge, see Submerging the Cleaner.
The cleaner does not stay firmly on the pool bottom.	There is air in the appliance casing.	Remove cleaner from the pool and re-submerge, see Submerging the Cleaner.
	The filter canister is full or dirty.	Remove cleaner from the pool. Clean the filter canister, see Cleaning the Filter Canister.
The cleaner does not or no longer climbs the pool walls.	The filter canister is full or dirty.	Remove cleaner from the pool. Clean the filter canister, see Cleaning the Filter Canister.
	Walls of pool are slippery or slimy. Although the water seems clear, microscopic algae, invisible to the human eye, are present in the pool. As a result the pool sides become slippery and prevent the cleaner from climbing. Check tires for wear and replace as necessary.	Remove cleaner from the pool. Do a shock chlorination treatment to eliminate algae. DO NOT leave the cleaner in the pool during this treatment.
On startup the cleaner does not move.	No power supply to the cleaner.	Remove cleaner from the pool. Check that the power outlet to which the Control box is connected is operating correctly by plugging another device into the power outlet..
	Unit is turned ON.	Check that you have started one (1) of the two (2) programs and check that the indicator for the selected program is lit. If the indicator light is not lit, turn the wheels then disconnect the control box and wait at least 20 seconds before reconnecting. If the problem persists, contact Baracuda Customer Service at 1300 784 423
Cable is tangling in the pool	Too much cable length in the water.	Remove cleaner from the pool. Do not unravel the entire cable. Use only maximum cable length to cover the pool area. Place the remaining unused cable on the side of the pool. Adjust the entry location in the pool to correct cord tangling. Follow the procedure in Cord Tangling to avoid and correct tangled cord.
The cleaner is not cleaning effectively.	The brushes have become smooth or the "wear" indicator shows.	Remove cleaner from the pool. Replace the brushes following the procedure in Replacing the Brushes.
	Filter canister is full or dirty.	Remove cleaner from the pool. Clean the filter canister following the procedure in Cleaning the Filter Canister.
	Floating cable is excessively coiled or kinked.	Remove cleaner from the pool. Make sure the floating cable is spread out over the pool. Ensure the cable is not too tightly wrapped or coiled when storing. If the problem persists, lay the cable straight in the sun to relax it and remove kinks. Follow the procedure in Cord Tangling to avoid and correct tangled cord.

## Section 7. Conformity



The manufacturer reserves the right to modify these specifications without notice. Although the robotic pool cleaners have been tested in a large variety of swimming pools, Fluidra cannot guarantee that this robotic pool cleaner will be compatible with all pools. Some pool features may affect performance. For further advice, please contact your Baracuda dealer.



For full warranty terms and conditions and to register your warranty, visit <https://warranty.baracuda.com.au/> and complete your details. Or scan the QR code to go directly to the registration page

Record your equipment details here for quick reference:

Model No. : \_\_\_\_\_

Serial No. : \_\_\_\_\_

# BARACUDA®

For Everyday Aussie pools

A Fluidra Brand | [Baracuda.com.au](http://Baracuda.com.au) | [Baracuda.co.nz](http://Baracuda.co.nz)

Fluidra Group Australia Pty Ltd | 1 Herbert Place, Smithfield NSW 2164, PO Box 7238 Wetherill Park NSW 1851, Australia | ABN: 87 002 641 965 | 1300 186 875  
Fluidra NZ Ltd | 13 Douglas Alexander Parade | Rosedale Auckland 0632, New Zealand | NZBN: 942 903 181 70759 | 0800 807 665

©2024 BARACUDA is a registered trademark of Fluidra Group Australia Pty Ltd., used under license. This document is subject to change without notice.

H0738500\_REVC